

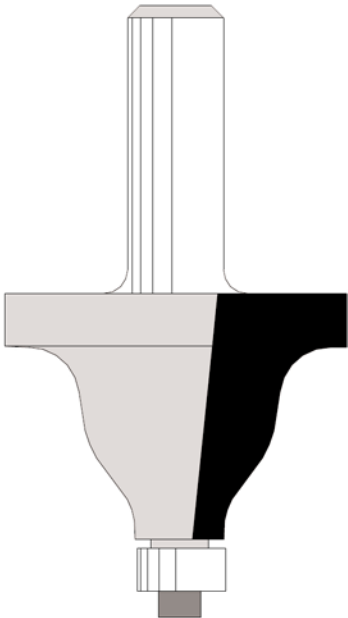

Manor

 **VELEPEC** \$157.50
 Product ID: VEL-60-127
 Diameter: 2-1/4"
 Cutting length: 1"
 Bearing guide: VEL-12-145

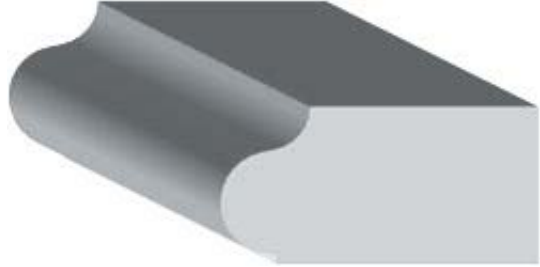

Beverly

 **VELEPEC** \$157.50
 Product ID: VEL-60-128
 Diameter: 1-3/4"
 Cutting length: 1-1/4"
 Bearing guide: VEL-12-145

 **Amana Tool** \$76.99
 Product ID: AMA-57246
 Diameter: 2-5/8"
 Cutting length: 1"
 Bearing guide: AMA-47707

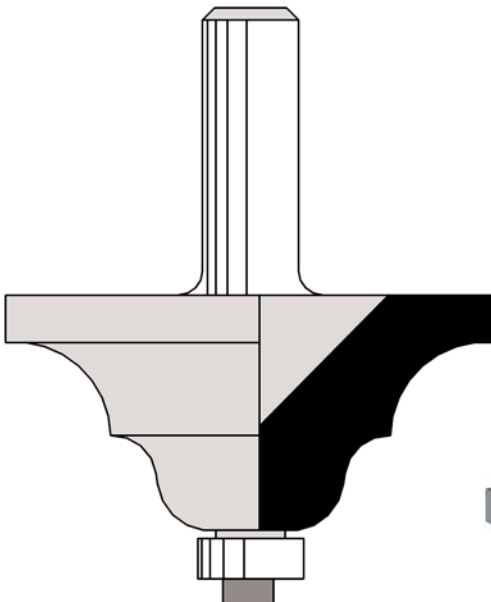
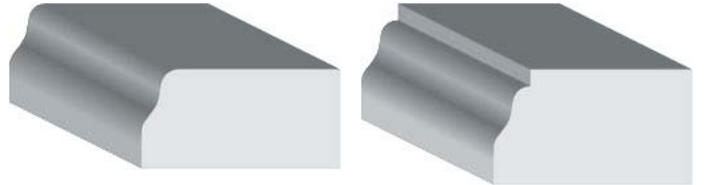

Bangor

 **VELEPEC** \$144.00
 Product ID: VEL-60-130
 Diameter: 2-1/2"
 Cutting length: 1-1/4"
 Bearing guide: VEL-12-145

