





## Oakdale

 **VELEPEC** \$189.00  
 Product ID: VEL-60-120  
 Diameter: 1-1/2"  
 Cutting length: 2"  
 Bearing guide: VEL-12-160

 **Amana Tool** \$110.21  
 Product ID: AMA-57238  
 Diameter: 2-5/8"  
 Cutting length: 1"  
 Bearing guide: AMA-47712

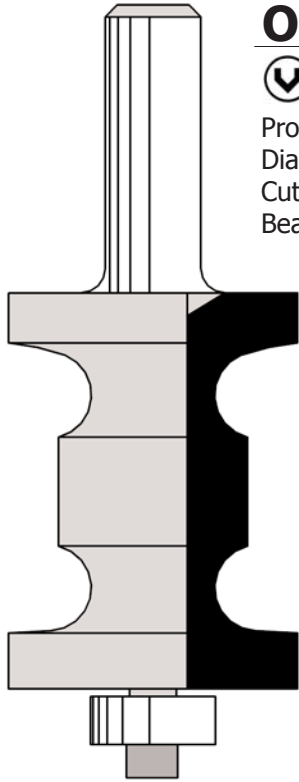

## Ontario

 **VELEPEC** \$180.00  
 Product ID: VEL-60-121  
 Diameter: 1-1/2"  
 Cutting length: 2"

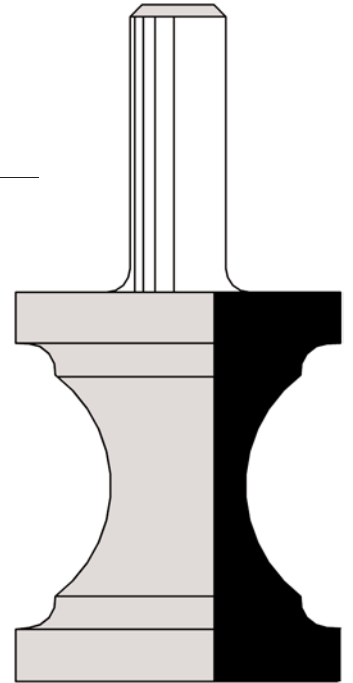
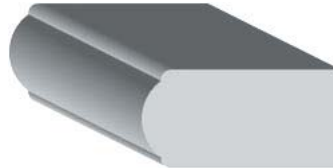

## N. Ocean

 **VELEPEC** \$130.50  
 Product ID: VEL-60-122  
 Diameter: 1-3/8"  
 Cutting length: 3/4"  
 Bearing guide: VEL-12-340

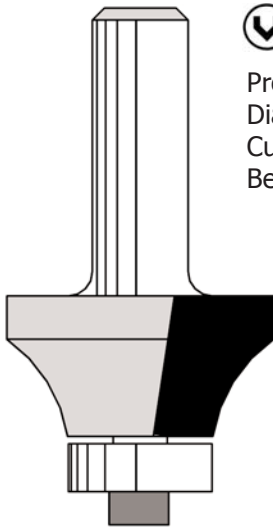

## S. Ocean

 **VELEPEC** \$144.00  
 Product ID: VEL-60-123  
 Diameter: 1-3/4"  
 Cutting length: 3/4"  
 Bearing guide: VEL-12-170

